



Owner's Manual Care and Maintenance

INFINITY[®]

from **MARVIN**[®]

REPLACEMENT WINDOWS

Built for life[®]



Table of Contents

04	INTRODUCTION
04	How to Use this Manual
04	Warranty Registration
05	Hazard Notations
05	ANNUAL CHECKLIST
06	PART IDENTIFICATION
06	Windows
07	Doors
08	GLASS
08	Condensation
08	Mildew Removal
09	Tempered Glass
09	Glass Breakage
09	Cleaning Glass
10	INTERIOR EVERWOOD® FINISH
10	Finishing or Painting EverWood
10	Preparing and Cleaning EverWood
10	Applying a High-Quality Gel Stain
11	Applying a Protective Top Coat Finish
11	Applying a Paint Finish
11	BARE INTERIOR WOOD
11	Painting Wood
11	Staining Wood
12	ULTREX® FIBERGLASS
12	Cleaning Ultrex
12	Painting Ultrex
13	HARDWARE
13	Cleaning Hardware
13	Physical Vapor Deposition (PVD) Finish
13	SCREEN
13	Cleaning Screen
14	CARE AND MAINTENANCE
15	Double and Single Hung
18	Slider/Glider
19	Casement
20	Awning
21	Special Shape and Round Top
22	Sliding French/Patio Door
24	Swinging French Door
27	Bi-Fold Door

Welcome to the Infinity family

Thank you for your recent purchase of durable, beautiful, and low-maintenance Infinity from Marvin windows and doors.

How to Use this Manual

This manual is designed to teach you the basics about your new Infinity windows and doors. You'll find photos to help you identify your Infinity products, general information on cleaning, and answers to common questions. There are also simple, small things you can do to ensure satisfaction. If you have a question or experience a problem with your windows that is not mentioned in this manual, just call your local Infinity partner for help or visit infinitywindows.com.

Warranty

Infinity from Marvin is committed to bringing you products of the highest quality and value. Our made-to-order manufacturing philosophy is one example of our commitment. Our warranty, another.

Please visit the warranty section of our website infinitywindows.com/warranty for full warranty details on your product.

Warranty Registration

To obtain the Limited Lifetime Warranty, you must register your products with Infinity within 60 days of product installation by completing the Warranty Registration form available at infinitywindows.com/warranty. You may also register by calling 1-800-533-6898. If you do not register your products within 60 days of installation, you will not receive the Limited Lifetime Warranty; instead, you will receive the 10/20 Limited Warranty.



Hazard Notations

Please familiarize yourself with the following hazard notations used throughout this manual.



WARNING

Mistake or misuse could result in personal injury and/or severe damage to unit, equipment, and/or structure.



SEEK ASSISTANCE

Help from another individual is necessary to perform the task safely and correctly.



CAUTION

Mistake or misuse could cause damage to the window or result in faulty installation and unit performance.



TIPS/HINTS

Information on alternative procedure, definitions, and helpful hints.

ANNUAL CHECKLIST

Keep your windows and doors operating smoothly with routine care and maintenance

- 01 Safety first: use caution on ladders and wear protective eye-wear and clothing. When working with primers, paints, stains, cleaning solutions, etc., make sure to use and dispose according to local codes or manufacturer's instructions.
- 02 Inspect weather strip for damage or loss of performance. Your local Infinity partner can help determine if the weather strip needs replacement. Take care when using paints, stains, or varnishes as these products can damage weather stripping.
- 03 Examine window or door's interior and exterior finish. Periodic cleaning and touch-up can extend the life of your finish. (See repainting/refinishing information on pages 10 through 12).
- 04 Inspect exterior caulking around the outer edges of the window or door frame, trim off any loose caulk, and reseal any gaps with a good quality caulk.
- 05 Check all hardware (locks, opening mechanisms, etc.) for smooth operation.
- 06 Inspect exposed hardware screws; tighten if loose.
- 07 Clean sand, dirt, or dust from door and window hinges, sills, and tracks.
- 08 Life happens, windows and doors get dirty. Wash your windows and doors with an approved cleaning solution found at infinitywindows.com/care.

Windows

In this manual, you'll find operation and maintenance information for Infinity from Marvin windows beginning on page 15. Refer to the product illustrations for the names of your particular windows, and use the illustration to help identify window components.

*Infinity Double Hung shown for illustrative purposes only.

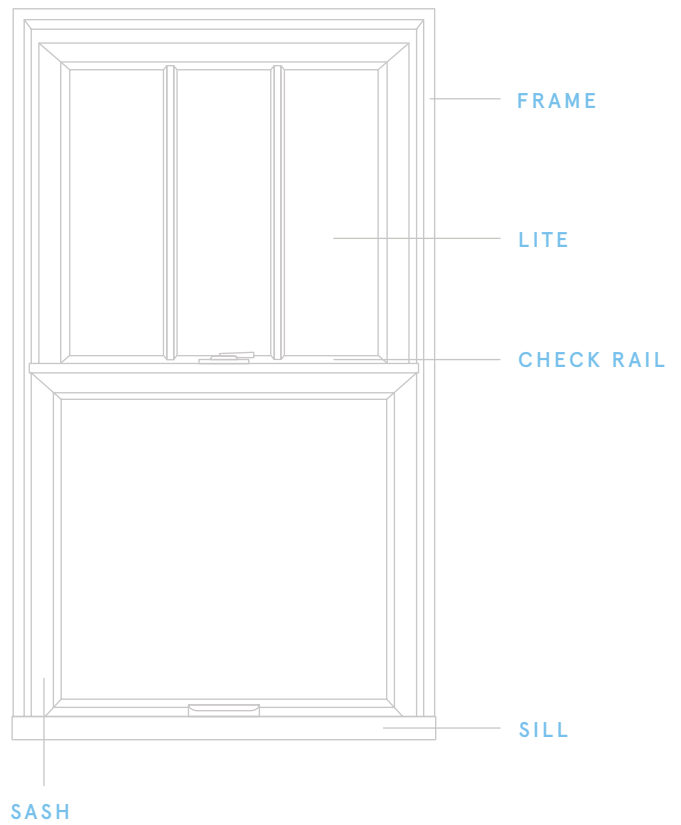

Infinity Window Styles

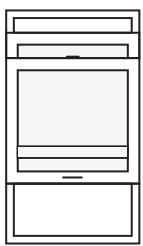

DOUBLE HUNG

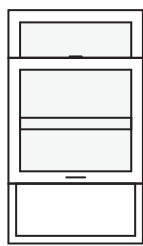

SINGLE HUNG

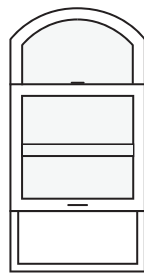

SINGLE HUNG
ROUND TOP

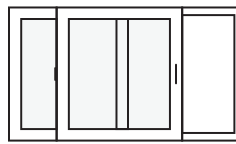

SLIDER

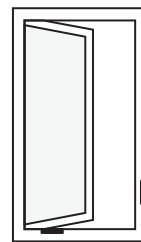

CASEMENT



AWNING

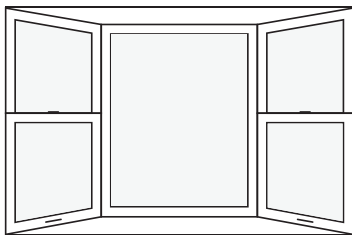

BAY

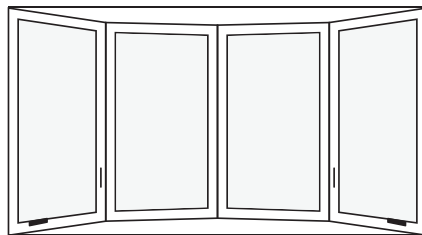

BOW

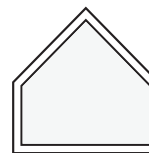

SPECIAL SHAPE



ROUND TOP

Doors

In this manual, you'll find operation and maintenance information for Infinity from Marvin doors beginning on page 22. Refer to the product illustrations for the names of your particular doors, and use the illustration below to help identify door components.

Sliding French and sliding patio doors are available in 2, 3, and 4 panel configurations. The swinging French door is available in 1, 2, and 3 panel configurations. The bi-fold door is available in up to 7 panel configurations.

*Infinity Sliding Patio Door shown for illustrative purposes only.

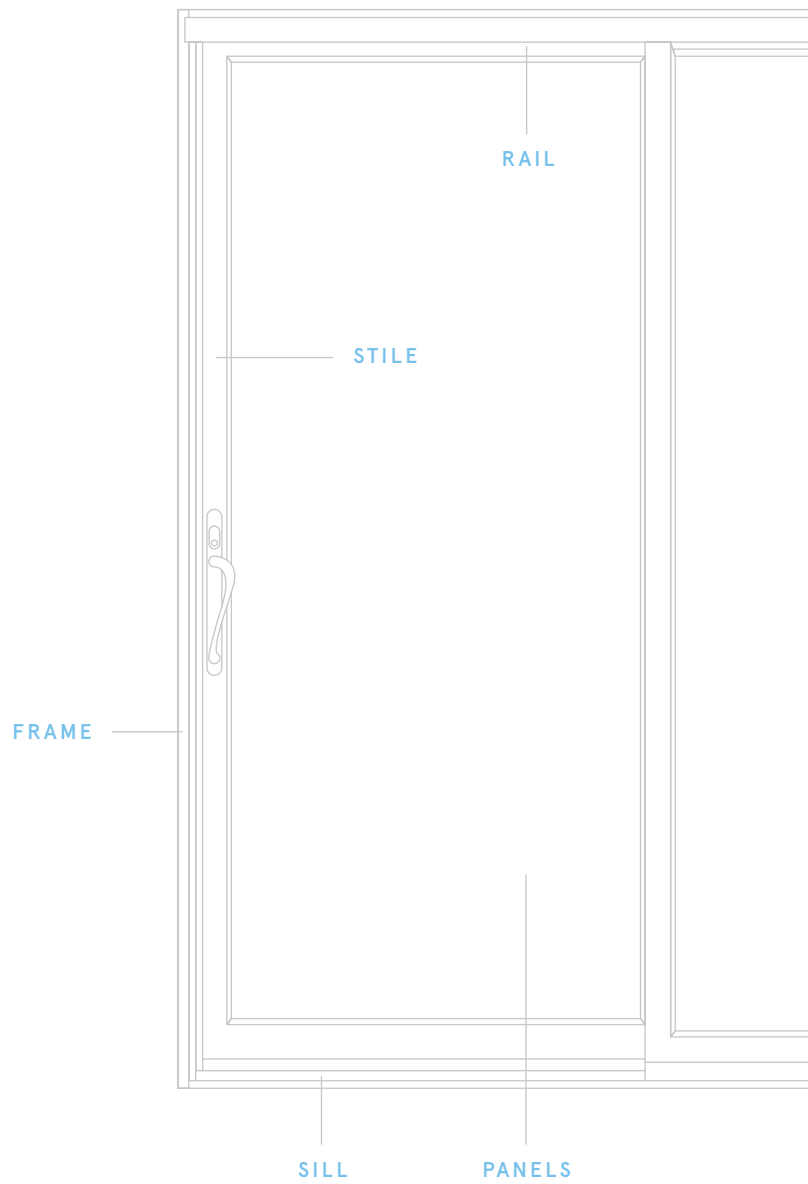

Infinity Door Styles

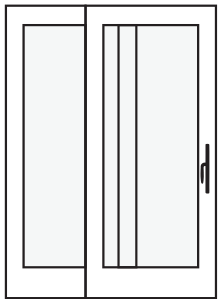

SLIDING FRENCH DOOR

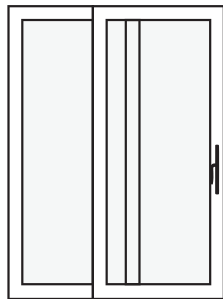

SLIDING PATIO DOOR

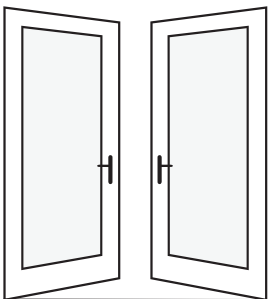

SWINGING FRENCH DOOR

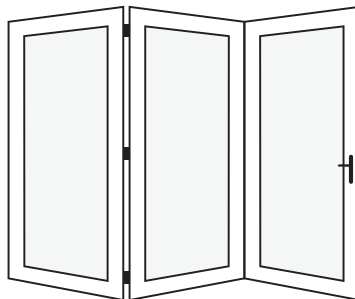

BI-FOLD DOOR

Keep your glass looking and performing its best.

Condensation

Before reading this section, pour yourself a nice tall glass of ice water. During cold winters, there is a large temperature difference between inside and outside of your home. When the temperature drops outdoors, the glass on your windows usually has a lower surface temperature than other surfaces in your home, and is the first place that you'll notice condensation. This is not due to any defect in your window or door, it's simply a sign of needing to reduce the humidity in your home.

Warm air is capable of holding more moisture than cool air. As warm vapor-filled air comes in contact with a cool surface, it loses its ability to hold moisture. When moisture-laden air reaches its dew point, moisture condenses on the nearest cool surface. Generally, the most obvious surfaces in your home where you'll notice condensation are on your windows or the glass of ice water sitting in front of you.

Excessive humidity is more likely to occur in newer or recently remodeled homes with tight, energy-efficient construction, causing a build-up of moisture to the interior. Information on excessive humidity and how to reduce condensation on your windows can be found on the Internet by searching for "window condensation".

Mildew Removal

If your home has excessive interior moisture, you may experience some discoloration on various parts of your home, including the lower portions of your windows or doors. This discoloration may be the result of mildew growth and can be removed with an approved cleaning solution found at infinitywindows.com/care.

Mildew is a fungus that thrives on warmth and moisture. Mildew growth is usually brown or black in color and may be mistaken for dirt. The presence of mildew can be confirmed by placing a drop of household bleach on the suspected mildew area. If small gas bubbles develop in the droplet of bleach, mildew does exist and can be removed with an approved cleaning solution found at infinitywindows.com/care.



Wear protective eyewear and skin protection, and keep the area well ventilated.
Make sure the surface is clean and reapply if the discoloration persists.



Tempered Glass

Tempered glass is sometimes used on Infinity windows and doors for code or safety reasons. Tempered glass is heated and cooled at an accelerated rate, adding strength and shatter resistance. You may notice a slight amount of distortion – this is normal and due to the tempered glass manufacturing process. The logo in the corner of each piece of tempered glass is required by code and safety regulations.

Glass Breakage



Should the glass in your window or door break, make sure you use the appropriate personal protection equipment to remove the broken glass; eyeglasses or goggles, sturdy gloves, and heavy protective clothing. Dispose of broken glass in a secure container. Failure to properly handle and dispose of glass could result in injury.

*Contact your Infinity partner for information on sash or panel replacement.

Cleaning Glass

The best method to clean the glass on your Infinity products is to first soak the glass surface with clean water to loosen dirt or debris. Use an approved cleaning solution found at infinitywindows.com/care and apply with a scratch resistant applicator. Immediately after washing the glass, remove all of the cleaning solution with a squeegee and make sure no harsh particles are trapped between the glass and the cleaning material. Window and door gaskets, sealants, and frames are susceptible to deterioration if cleaning solutions are not rinsed and dried after cleaning.



Do not use razor blades, knives, or scrapers for cleaning glass surfaces.

DO

- Clean glass when dirt and residue appear.
- Determine if coated glass surfaces are exposed.
- Exercise special care when cleaning coated glass surfaces.
- Start cleaning at the top of the building and continue to lower levels.
- Soak the glass with clean water to loosen dirt and debris.
- Use an approved cleaning solution found at infinitywindows.com/care.
- Dry all cleaning solution from window gaskets, sealants, and frames.
- Clean one small window and check to see if procedures have caused any damage.

DON'T

- Use scrapers of any size or type for cleaning glass.
- Allow dirt and residue to remain on glass for an extended period of time.
- Clean tinted or coated glass in direct sunlight.
- Allow water or cleaning residue to remain on glass or adjacent materials.
- Begin cleaning without rinsing excessive dirt debris.
- Use abrasive cleaning solutions or materials.
- Allow metal parts of cleaning equipment to contact the glass.
- Trap abrasive particles between the cleaning materials and glass surface.

Looks and stains like wood — without the maintenance.

Read these instructions thoroughly before beginning to stain or paint your Infinity window or door. Once finished, it is very difficult to remove the stain or paint and refinish the unit.

Finishing or Painting EverWood

Stainable, paintable Infinity products feature EverWood, an interior engineered wood grain surface that requires a paint or gel stain finish to be applied before or immediately after installation.



When applying gel stain or paint finish, avoid contact with plastic or vinyl parts such as weather strip, hardware, handles, or rollers. Stain and paints can cause damage and may require replacement.

DON'T

- Sand or use abrasive cleaners on EverWood.
- Allow EverWood to come in contact with petroleum distillates such as benzene, toluene, or kerosene.
- Allow EverWood to come in contact with silicon or other adhesives prior to finishing.

Preparing and Cleaning EverWood

Clean the EverWood surface with a damp cloth soaked in warm water. Then wipe down with a dry cloth, and allow the surface to thoroughly dry. If the surface has become soiled, try cleaning with an approved cleaning solution found at infinitywindows.com/care. Rinse off cleaning residue with warm water and let thoroughly dry.

Applying a High-Quality Gel Stain

Read and follow the gel stain manufacturer's instructions and warnings for application, preparation, and clean up. Apply the gel stain with a brush in the direction of the wood grain on the supplied test strip of EverWood to determine if the gel stain adequately matches your desired finish before applying stain to the unit.

If the stock gel stain applied to the EverWood test strip does not match your desired finish, it is possible to custom mix gel stains by adding colorants or combining colors. The exact process will depend on the brand of gel stain you are using. Infinity recommends contacting a stain/paint specialty store to custom mix a matching color for your application.

After a good match has been obtained on a sample, apply gel stain evenly with a brush to the unit.



Applying a Protective Top Coat Finish

Let the gel stain dry overnight. Test an area to see if the surface is dry by wiping the stained surface with a clean cloth. If stain appears on the cloth, the stain needs to dry longer. After the stain has completely dried, Infinity recommends using a high-quality, water-based polyurethane finish. Follow the finish manufacturer's instructions and warnings for application, surface preparation, and clean up. Use a clean brush to apply a top coat, lightly sand the surface with 400 grit sandpaper taking extra care not to sand through the finish surface, then apply one more coat of finish.

Applying a Paint Finish

Read and follow the paint manufacturer's instructions and warnings for application, preparation, and clean up. Test a high-quality latex or oil-based paint applied in the direction of the wood grain on a sample piece of EverWood before applying paint to the unit.



EverWood does not require the use of a prime coat.
One coat of high-quality paint generally provides adequate coverage.

BARE INTERIOR WOOD

Finishing or painting bare wood products from the Marvin Elevate® Collection.

If you have a brand new, bare wood Elevate door, you must finish it immediately to prevent possible damage to the wood. Make sure bare wood door interior surface is clean and dry. Remove any handling marks, debris, or effects of exposure to moisture by sanding lightly with fine sandpaper and wiping clean before applying your choice of finish. It is important that you do not paint locks, hardware, weather strip, or jamb liners. Avoid contact with plastic parts and vinyl weather strip; paint and stain can damage these parts.

Painting Wood

Use only a high-quality, oil-base or latex-base paint. To provide a good adhesion of paint, a compatible prime coat should be applied. Paint with panels opened or removed, and do not close until thoroughly dry. Apply one coat of primer and two coats of top-quality paint according to the paint manufacturer's instructions.



Do not apply paint to the Marvin Elevate Collection factory prefinish without first contacting your Infinity dealer for proper instructions.

Staining Wood

Apply stain according to the manufacturer's instructions. Apply as many coats of stain as necessary to achieve the desired color. After the stain is thoroughly dry, apply at least two coats of finish. Marvin recommends varnish or polyurethane.



Prior to staining natural wood it is desirable to apply a wood conditioner to obtain a more even finish. Follow manufacturer's instructions.

Easy cleaning for a fiberglass finish that lasts.

Infinity windows and doors are built with strong, durable Ultrex fiberglass that is 8 times stronger than vinyl. Our proprietary finish is three times thicker than the competition, and performs without fear of UV degradation – and is virtually maintenance free. No sanding, scraping, or painting required.

Cleaning Ultrex

Remove dirt by washing with an approved cleaning solution found at infinitywindows.com/care and rinse with water. Clean with a soft cloth or soft brush to remove any bugs, grime, dirt, or dust. Do not use an abrasive applicator or use extreme pressure.

No solvents, paint thinner, or other chemicals of any type are recommended for use with Ultrex, as they may affect the functionality and appearance of the coating.

DON'T

- Apply approved cleaning solutions with any abrasive materials or applicators.
- Use a scrubbing action or extreme pressure.
- Use solvents, paint thinner, or other chemicals, as they may affect the integrity, functionality, and appearance of the coating.



Do not allow naphtha to come in contact with EverWood® material.

Painting Ultrex

You will need to supply:

- 320-400 grit sandpaper
- Masking tape
- Foam painting brush
- Quality exterior grade acrylic latex paint

01 Thoroughly sand the factory finish with 320-400 grit sandpaper.

02 Wash the surface with water and an approved cleaning solution found at infinitywindows.com/care to remove contaminants, rinse with clean water, and dry thoroughly.

03 Mask any window components that will not be painted.

04 Coat the Ultrex with a quality exterior grade acrylic latex paint.

05 Acrylic latex products gain full adhesion after seven to ten days cure.

Keep handles and locks looking their best.

Cleaning Hardware

Use a clean, soft, damp cloth to polish and remove fingerprints from window and door hardware. To remove heavier deposits, use an approved cleaning solution found at infinitywindows.com/care. Remove traces of water and cleaner and dry thoroughly with a soft cloth. When using any proprietary cleaner, always follow the advice given by the manufacturer.

DON'T

- Use household cleaners, window cleaning solutions, abrasive cleaners, bleaches, solvents, polishes, or other chemicals unless specifically recommended by the hardware's manufacturer.
- Allow keys, rings, or other sharp objects to strike the hardware.

Physical Vapor Deposition (PVD) Finish

PVD finishes are available as an option for door hardware. PVD hardware undergoes a state-of-the-art process known as Physical Vapor Deposition. A layer of hard-wearing metals is deposited onto the solid brass substrate, giving it a tough finish to resist fading and discoloration by direct sunlight, humidity, and most other environmental factors, even in coastal areas.

To help retain the appearance of your PVD products for many years to come, a little periodic maintenance is required to remove any atmospheric deposits from the surface of the product.

- Once every two months, clean the surface of the product thoroughly with a non-abrasive cloth and warm water.
- To remove heavier deposits, use an approved cleaning solution found at infinitywindows.com/care. Remove traces of water and cleaner and dry thoroughly with a soft cloth.
- When using any proprietary cleaner always follow the advice given by the manufacturer in handling cleaning materials.
- Do not use any abrasive cleaning materials or solvents when cleaning your PVD products.

Keeping your screens clean.

Cleaning Screen

Remove the screens, lay them on a flat clean area, and spray off any dust or debris with water from your garden hose. Allow the screens to completely air dry before replacing in the window or door. If you live in a cold climate, it is recommended that in the winter you remove the screen from your doors. The mesh may collect snow and ice, causing it to sag. Please see individual sections for instructions on screen removal, and see page 27 for bi-fold pleated screen instructions. Contact your Infinity partner if you require assistance with screen replacement.



Infinity screens are designed to stand up to everyday use. However, screens are not intended to act as a safety device. Do not allow children or pets to sit or play on window sills, or to push or fall against window screens, as this could result in a fall through the window or door opening.



Screen will not stop child from falling out window. Keep child away from open window.

Taking care of your Infinity windows and doors.

Information in this section includes maintenance and operational tips on Infinity products. Read completely through the instructions before beginning to work on your windows to make sure you have any necessary tools and parts.

Exterior finishes on doors can be cared for in the same manner as Infinity windows. See interior and exterior maintenance information. Take care with your door's sill – make sure you prevent damage by not getting any paint, solvent, or chemicals on sills. See individual door sections for any specialized sill care.

If you are having problems not explained in this manual, or continue to have issues, contact your local Infinity partner.



When contacting your Infinity partner it may be helpful to provide them with the "Customer Service Serial Number" etched on the upper right corner of the glass.

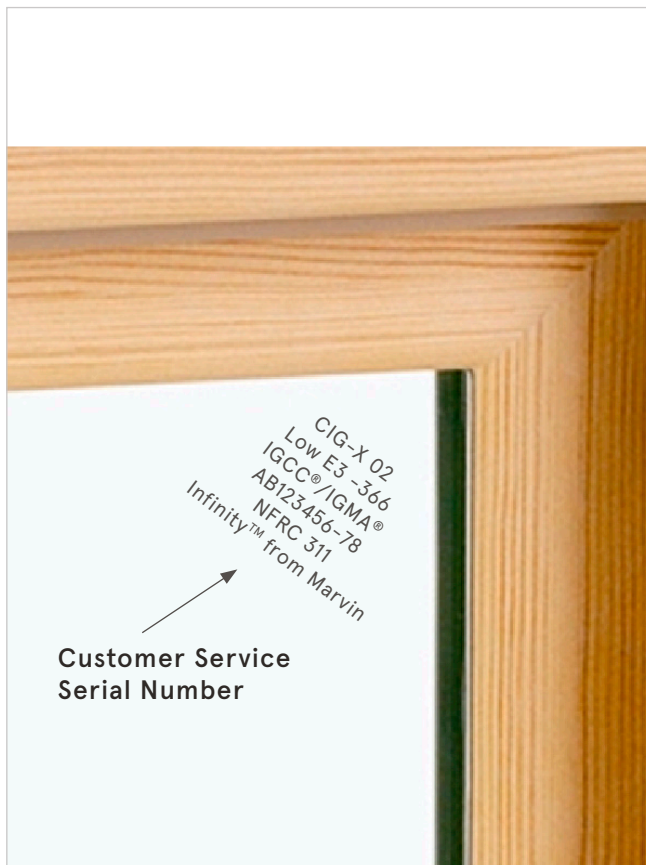

LOW E3 OPTION

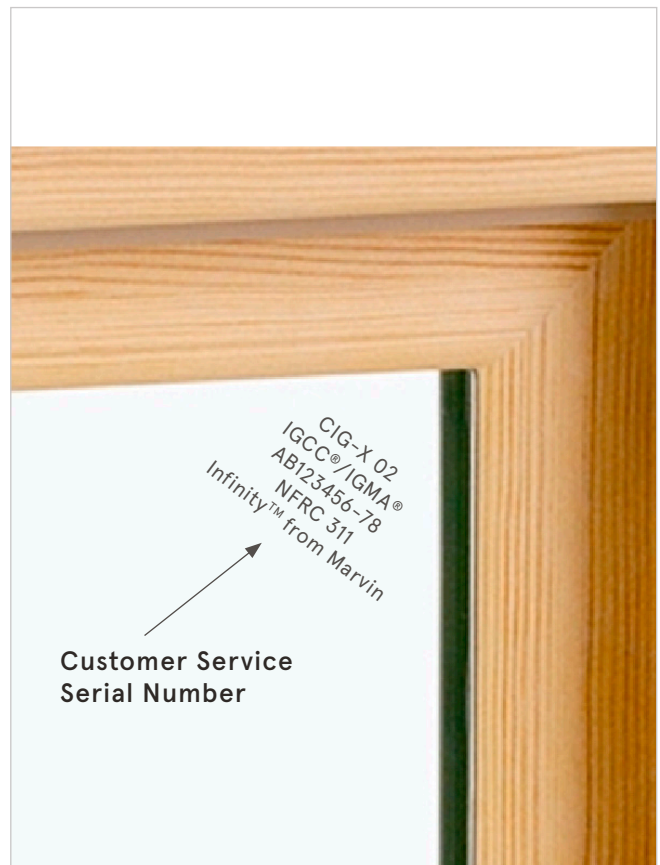

LOW E2 OPTION

Double Hung and Single Hung

Operation and Maintenance

Double hung windows have two operable sash in the frame that slide up and down. Single hung windows have a fixed upper sash and a bottom sash in the frame that slides up and down.

Periodically clean the jamb where the sash slides. Keep dirt and grease free by washing with a gentle dish detergent. Check the exterior caulking on your double hung windows annually. Visit [infinitywindows.com/windows/double-hung](https://www.infinitywindows.com/windows/double-hung), [infinitywindows.com/windows/single-hung](https://www.infinitywindows.com/windows/single-hung), or [infinitywindows.com/windows/single-hung-round-top](https://www.infinitywindows.com/windows/single-hung-round-top) to find videos on proper cleaning and operation.

How to Tilt Your Double and Single Hung Sash

To tilt the bottom sash, unlock the unit and raise the sash about 4". Push down on the tilt button located on top of the sash lock base. Rotate the sash lock past the tilt button and ease top edge of bottom sash to a horizontal position.

To tilt the top sash, lower the sash about half-way. Pull the tilt latches inward (located on the top edge of the sash rail) simultaneously until they clear unit frame. Ease top of sash to a horizontal position.

*Only the bottom sash will tilt on a single hung window.



Removing Double and Single Hung Sash

To remove the bottom sash, tilt the sash using the same technique described in the previous section. When the sash is in a horizontal position, lift both sides of the sash upward 2-3" (51-76 mm) (raising pivot pins out of each clutch). Now, rotate the sash until pivot pins clear the jambs and remove the bottom sash from the frame.

To remove the top sash, tilt the sash using the same technique described in the previous section. When the sash is in a horizontal position, lift both sides upward 2-3" (51-76 mm) (raising pivot pins out of each clutch). Finally, rotate the sash until the pivot pins clear the jambs and remove the top sash from the frame.



Larger sized sash can be heavy and awkward to handle. To avoid injury, use assistance to remove larger sash.

Replacing Double and Single Hung Sash

For the top sash, hold the sash exterior side up with the top rail facing towards you. Rotate and insert the sash so the sash pins clear the frame and place it so the lower sash pin is 2-3" (51-76 mm) above the clutch. Rotate the sash to the horizontal position and lower it down until the pivot pins are fully seated into the clutches. Simultaneously pull in on both tilt latches and tilt the sash up into place. Release the tilt latches and operate the sash to ensure that the sash is operating smoothly. Check sash pivot pins to ensure they are fully engaged in the clutch cams before proceeding.

Repeat above procedures for bottom sash, except retract the sash check rail guides with the tilt button on the sash lock base when installing.

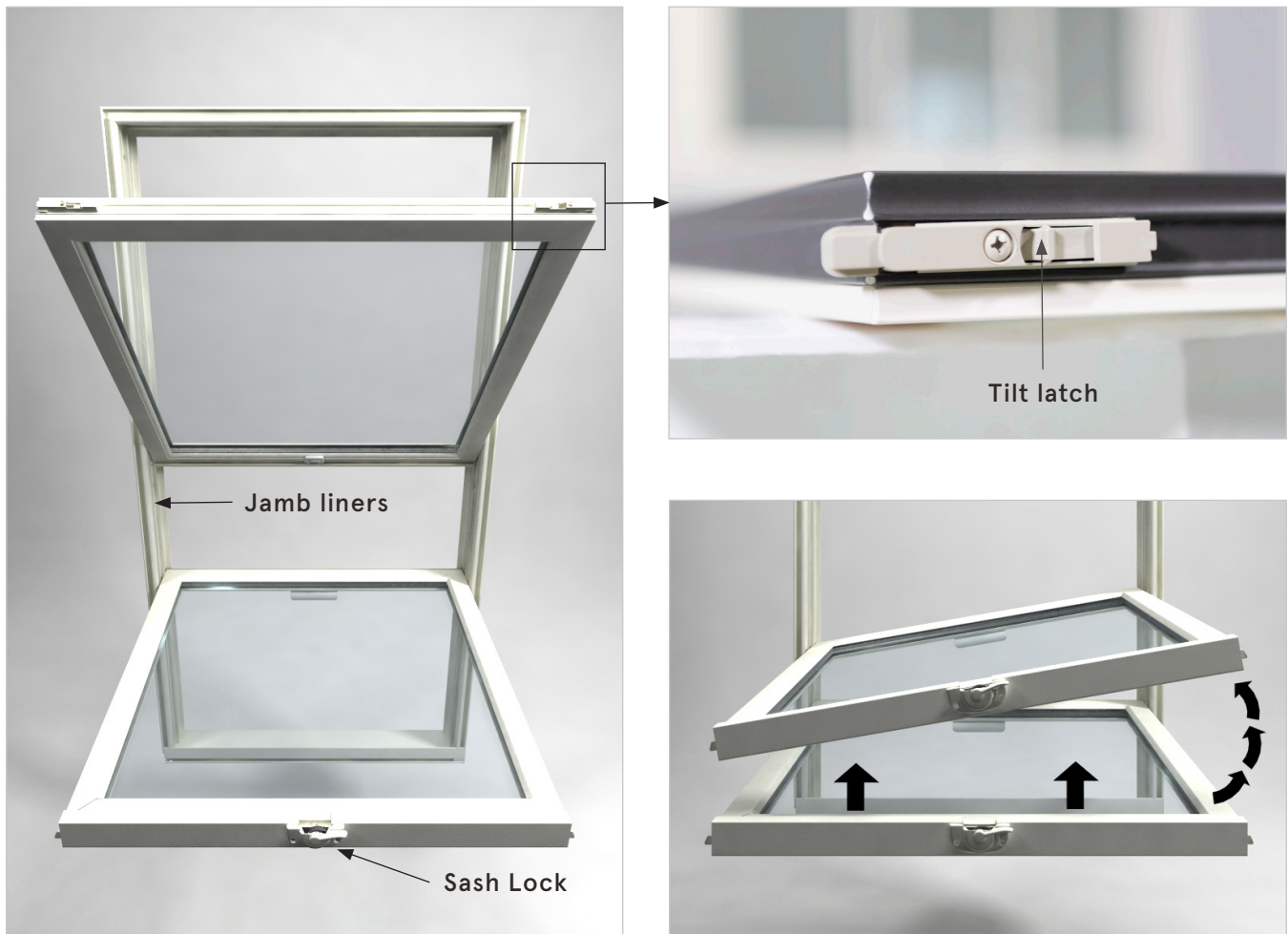

Resetting a Slipped Clutch Assembly

Measure the clutch dimension from the sill on the opposing balance assembly for the same sash and temporarily mark that dimension on the jamb carrier that contains the released clutch, must be within 1/8" (3 mm). Using a flat screwdriver, rotate the balance clutch cam in the clutch assembly to the released position. Hold the screwdriver firmly and slide the clutch assembly down the jamb carrier to the mark. Rotate the balance clutch cam to the open locked position (cam opening up). Release the screwdriver carefully from the clutch assembly (it must lock in place or damage will occur). Compare clutch heights from the sill for the sash affected. They MUST be within 1/8" (3 mm) of each other or damage may occur when sash are reinstalled, adjust height as needed.



Clutches are under extreme spring tension.

Removing and Installing the Screen

To remove the screen, lift up the bottom sash to its fully raised position. Grasp and pull inward on both plunger bolts and push outward on the screen. Grasp the frame of the screen and pull down slightly on the screen until it clears the screen channel. Turn the screen sideways and bring it in through the bottom sash opening. To replace the screen, reverse the above procedure.

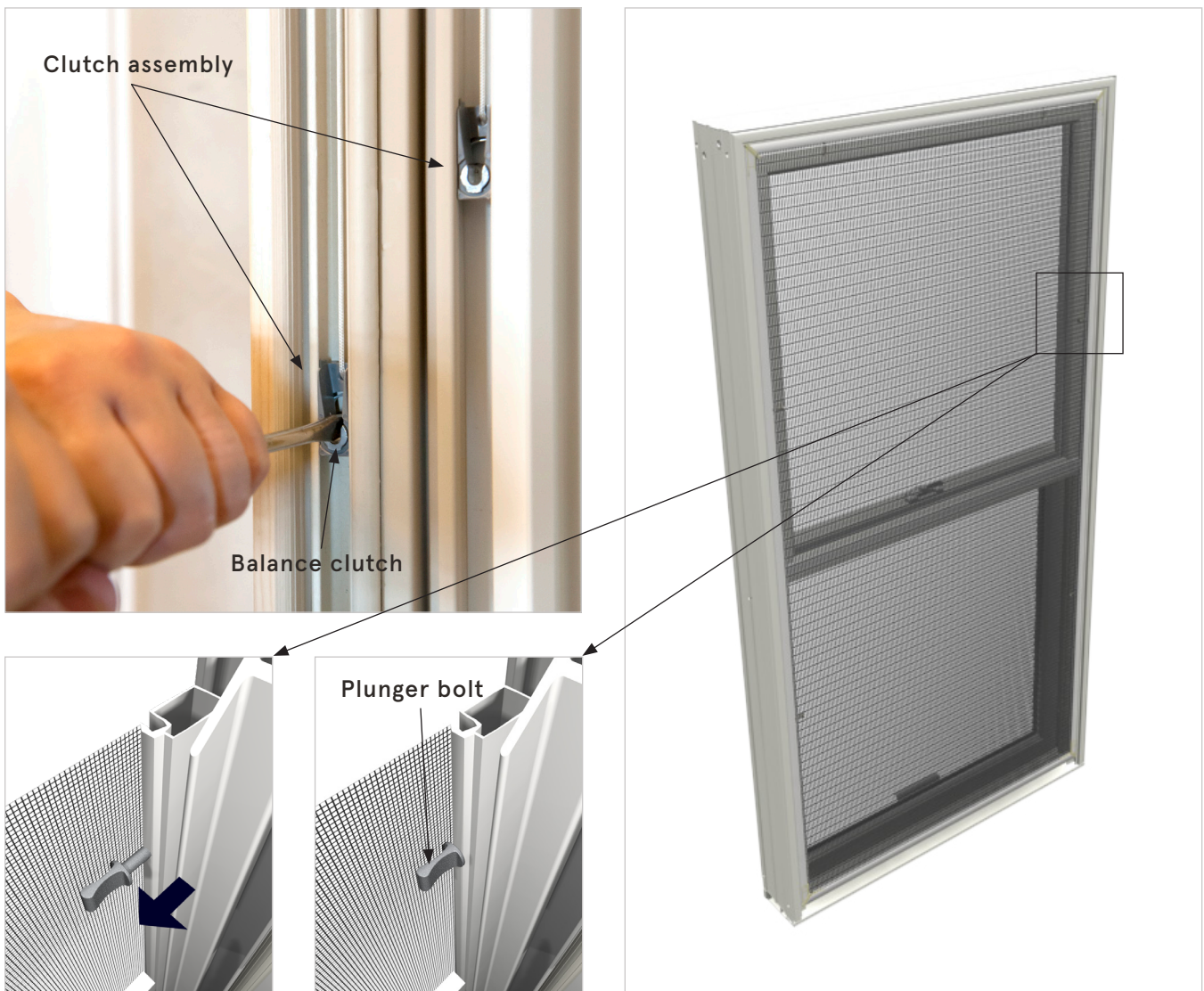

Slider/Glider

Operation and Maintenance

Slider windows glide horizontally from the left or right.

Periodically clean the tracks where the sash must glide. Keep tracks dirt and grease free, clean surface with a damp cloth soaked in warm water, and wipe down with a dry cloth allowing the surface to thoroughly dry. Visit infinitywindows.com/windows/slider to find a video on proper cleaning and operation.

Removing Slider Sash

Slide the operating sash to stationary side of the unit (2"-3" (51-76 mm) from stationary jamb). With latches depressed, located at the top of the sash, tilt the sash inward until it clears the unit frame; lift the sash off the sill track. To replace the sash, reverse the above procedures.

*Only the operating sash of a slider can be removed from the frame.

Removing and Installing the Screen

To remove the screen, open the operator sash completely. Grasp the screen pull tabs located on the jamb stile side of the screen. Pull the tabs toward the center of the unit until the screen frame can clear the screen channel. Push the screen out to the exterior and turn diagonally to bring into the dwelling.

Replace the screen with the operator sash completely open and position the screen on the exterior of the window with the springs toward the meeting stile of the unit. Making sure the springs are seated in the screen channel, pull on side tabs until the screen clears the frame. Pull screen in toward the interior until the jamb stile of the screen aligns with screen channel; release tabs.

*Pull tab away from frame and then push out.

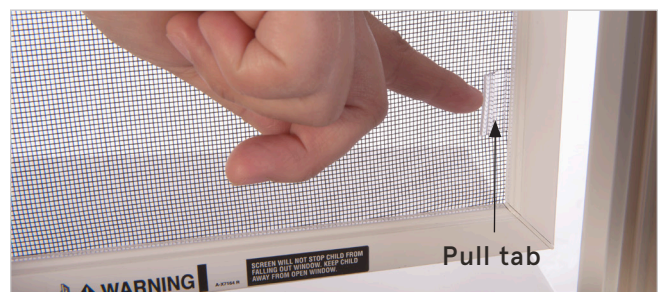
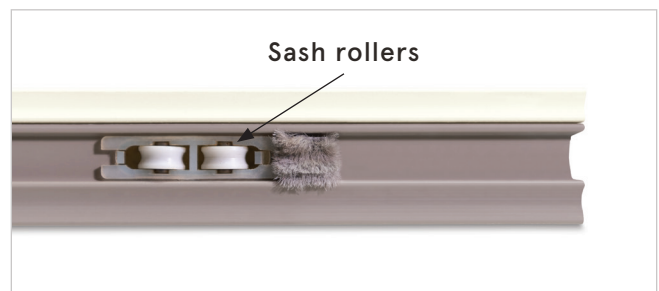

Casement

Operation and Maintenance

Casement windows are side-hinged to swing out from the left or right and crank in and out. The roto-gear is the operating mechanism that opens and closes your casement windows. Your casement lock seals the window tightly closed, so excessive cranking when closing your window does not improve the seal and may damage your roto-gear.

Roto-gears should be lubricated once a year with white lithium grease (available at any hardware store) to keep operation smooth. The hinge joints and locking mechanism should be lubricated on occasion with a silicone-based spray. Be sure to clean off all dirt, debris, or sand before lubrication.



Excessive lubrication may cause damage to the finish of your window.
Avoid getting oil and solvents on your finish.
Make sure that any excess is immediately removed.

The sash tracks should be occasionally cleaned out with a soft bristle brush. Visit infinitywindows.com/windows/casement to find a video on proper cleaning and operation. If your casement is less than 24 3/8" (721 mm) in width, your roto-gear arms and assembly may differ from those shown below.

Removing and Installing the Screen

To remove casement screen, grasp screen clip. Lift upward and draw screen towards you, removing screen from channel.

To install casement screen, place screen into the upper screen channel. Lift upward and push screen tight against frame. Release screen lift to seat screen into place.

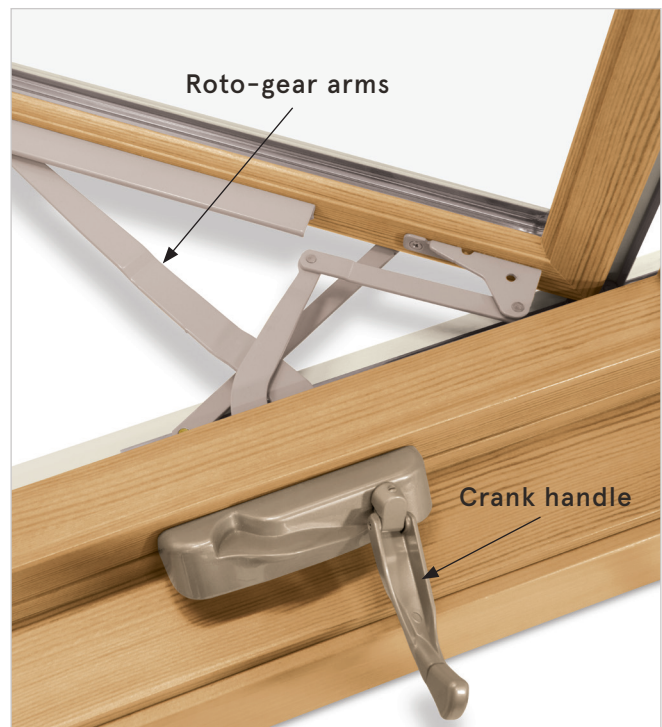

Awning

Operation and Maintenance

Awning windows are top-hinged and swing out from the bottom. The roto-gear is the operating mechanism that opens and closes your awning windows. Your awning lock seals the window tightly closed, so excessive cranking when closing your window does not improve the seal and may damage your roto-gear.

Roto-gears should be lubricated once a year with white lithium grease (available at any hardware store) to keep operation smooth. The hinge joints and locking mechanism should be lubricated on occasion with a silicone-based spray. Be sure to clean off all dirt, debris, or sand before lubrication.



Excessive lubrication may cause damage to the finish of your window.
 Avoid getting oil and solvents on your finish.
 Make sure that any excess is immediately removed.

The sash tracks should be occasionally cleaned out with a soft bristle brush. Visit infinitywindows.com/windows/awning to find a video on proper cleaning and operation.

Removing and Installing the Screen

To remove awning screen, grasp screen clip. Lift upward and draw screen towards you, removing screen from channel.

To install awning screen, place screen into the upper screen channel. Lift upward and push screen tight against frame. Release screen lift to seat screen into place.

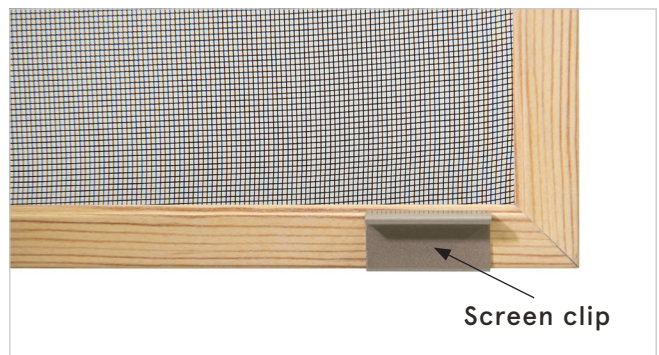
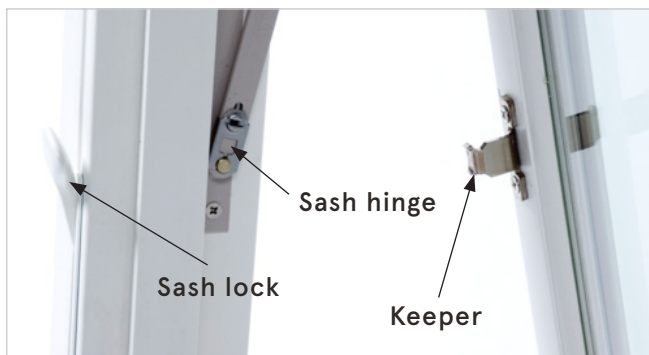
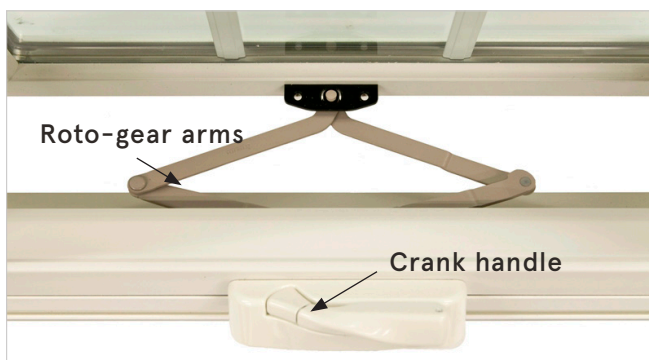

Special Shape and Round Top

Maintenance

Most Infinity Round Top and Special Shape Windows and all direct glaze windows are non-operational, meaning they do not open or close, so there are no maintenance requirements for hardware or weather stripping. Clean the glass occasionally and maintain the interior or exterior surfaces on the same schedule as your other windows.

Visit infinitywindows.com/windows/special-shape or infinitywindows.com/windows/round-top to find videos on proper cleaning.

Special Shapes

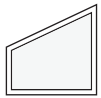

TRAPEZOID



PENTAGON



RIGHT
TRIANGLE



LEFT
TRIANGLE



OCTAGON



RECTANGLE



TRIANGLE



HEXAGON

Round Tops

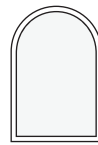

HALF ROUND
ABOVE
SPRINGLINE



EYEBROW
ABOVE
SPRINGLINE



RIGHT
QUARTER
ROUND



LEFT
QUARTER
ROUND



HALF ROUND



EYEBROW

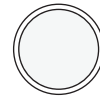

FULL CIRCLE

Sliding French/Patio Door

Operation and Maintenance

The sliding French/patio doors slide horizontally and require very little maintenance to keep them functioning efficiently.

Most problems can be eliminated by keeping the sill clean – ensuring smooth door operation. Door handles can be wiped down with a damp cloth to remove fingerprints and smudges. It is very seldom that door rollers, locks, and hinges require lubrication. Occasionally use spray lubricant to keep operation smooth (rollers are visible underneath the operator panel). Visit infinitywindows.com/doors/sliding-french or infinitywindows.com/doors/sliding-patio to find videos on proper operation.

If you live in a cold climate, it is recommended that you remove the screen door in the winter. The screen mesh may collect snow and ice, causing it to sag. If you need door panels removed, please contact your Infinity partner for either detailed instructions or for a service person to remove the panel for you.

Panel Adjustment Procedure

If necessary, panel adjustment allows you to make minor adjustments to your Infinity Sliding Patio or Sliding French Door after it has been permanently installed.

You will need to supply:

- Small putty knife
- Flat or Phillips screwdriver

- 01** Using small putty knife or screwdriver, remove two roller adjustment hole caps from bottom rail of operating panel.
- 02** Slide operating panel 1/2"-3/4" away from locking jamb.
- 03** Adjust rollers (to raise/lower panel) by turning adjustment screws with screwdriver.
- 04** If an even reveal is unobtainable along entire length of panel, ensure locking jamb is shimmed plumb and level.
- 05** Check panel operation. If satisfactory, replace adjustment hole caps.



Removing the Screen

To remove the screen panel, unlock and partially open the screen door. From the exterior, pry the screen panel guide up with a putty knife starting at one corner. Pull the guide off the track, working your way toward the other end. Once the bottom of the screen panel is completely released from the sill track, pivot the bottom of the screen out and push the top of panel approximately 5 degrees toward the head jamb.

This will release the screen panel rollers from the head jamb screen track. Remove the panel from the door.

To reinstall the screen, hold the screen panel with the top rollers facing you. While tilting the bottom of the screen panel away from the door, lift the rollers into the screen track and pull the panel toward your body to engage the rollers in the track. Make sure the rollers are seated in the track by moving the screen panel back and forth. Once you are sure the rollers are fully seated, pivot the screen panel into position toward the sill and place the bottom screen panel guide into the sill track by lifting it with your fingers or by lifting with a stiff putty knife.

The screen can be adjusted from the interior by loosening or tightening the top roller screw nearest the locking jamb. Adjust the screen so that it is parallel to the locking jamb or casing. An even reveal should be achieved along the entire height of the jamb.

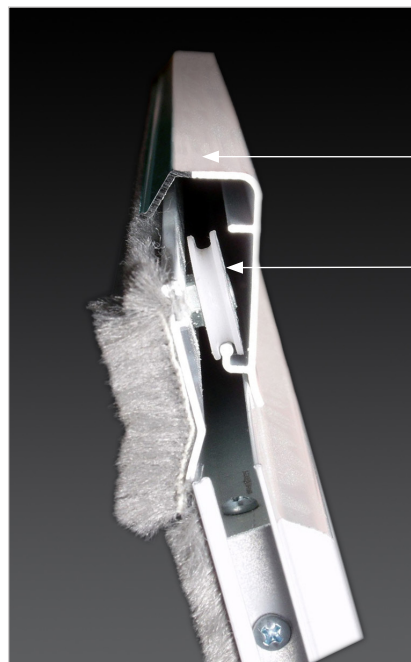

Screen Track

Screen Roller

Swinging French Door

Operation and Maintenance

The swinging French door requires very little maintenance.

To maintain sill appearance, wash with a mild soap and water solution. If you need door panels removed, please contact your Infinity partner for either detailed instructions or for a service person to remove the panel for you. Visit infinitywindows.com/doors/swinging-french to find videos on proper operation.

Handle Operation for Multi-Point Lock

Always close and lock your passive panel first and the operating panel (with thumb turn) second. Infinity's multi-point hardware has locking bolts at the head and base of the door. Lifting the handle 45 degrees upward will set the head and foot bolts in place for a secure seal. A 90 degree turn of the key from the outside or the thumb turn on the inside will lock the deadbolt in the handle assembly. When the deadbolt is unlocked, downward pressure on the handles will release the bolts and latch and the door will open. Securely lock by engaging the deadbolt, head, and foot bolts; using only one or the other does not offer full security.

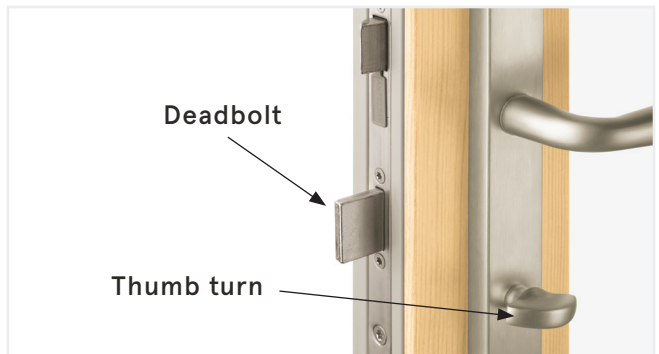
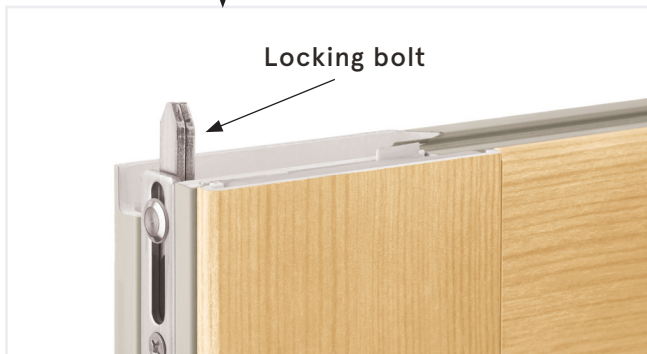
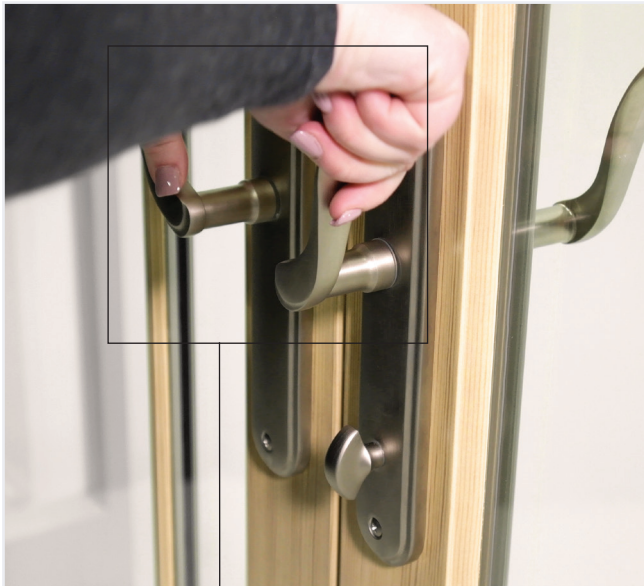

Hinge Adjustment Procedure

The Infinity Swinging French Door's adjustable hinge system allows you to make minor adjustments after it has been permanently installed.

*Adjustable hinges are not intended to compensate for an improperly installed unit.

Adjustments should only be made when panel misalignment is visible or causes poor operation of door/lock. Make any adjustments in small increments (one rotation per hinge), starting with the bottom hinge and working up to the top hinge. Repeat the process as necessary adjusting one rotation at a time. Check results, readjust, or proceed as required.

The vertical adjustment screws are located on the bottom of the hinge barrels. The horizontal adjustment screws are located on the face of the hinges. Each screw has an adjustment range of approximately 7 turns.

- 01** Check panel clearance at sill and head jamb. The panel should have 3/16" (5 mm) clearance at head jamb and at bottom.
- 02** Align panel vertically as needed by adjusting the screws on the bottom of the hinge barrels. The vertical adjustment screw should be adjusted equal amounts starting with the bottom hinge. Check index mark on hinge to determine amount and direction of panel movement. See illustration.
- 03** Check panel alignment with locking jamb; panel should have 3/16" (5 mm) clearance along the jamb.
- 04** Rotate horizontal adjustment screw clockwise to decrease, or counterclockwise to increase jamb/panel clearance at the appropriate hinge. If increasing clearance at top, bottom hinge may have to be adjusted to decrease clearance to avoid hinge binding. See illustration.

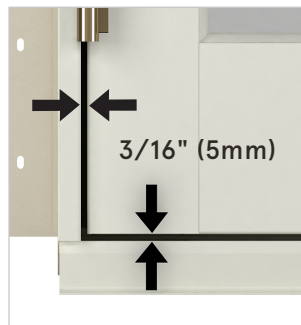
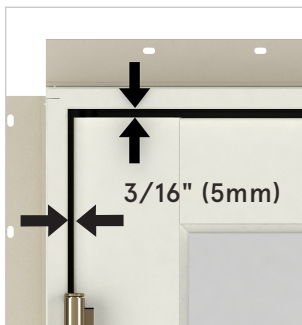

Removing the Screen

If you live in a cold climate, it is recommended that during the winter months you remove the screen door to avoid snow and ice from collecting, causing the mesh to sag.

To remove the swinging screen door, first open the active screen panel and disconnect the auto closer. Remove the #6 x 1/2" screw attaching the closer to the head jamb bracket. Then remove the hinge pins from the active screen panel hinges, remove the panel from the hinges, and store. On configurations with two operating panels, open the passive screen panel and remove the hinge pins in the same manner as the active.

Adjust the closing tension on your swinging screen door by loosening the two screws and attaching the door bracket to the screen panel. Slide the bracket and closer left or right as needed and tighten screws. Adjust the closing speed by tightening or loosening the adjusting screw located at the rear of the cylinder assembly.

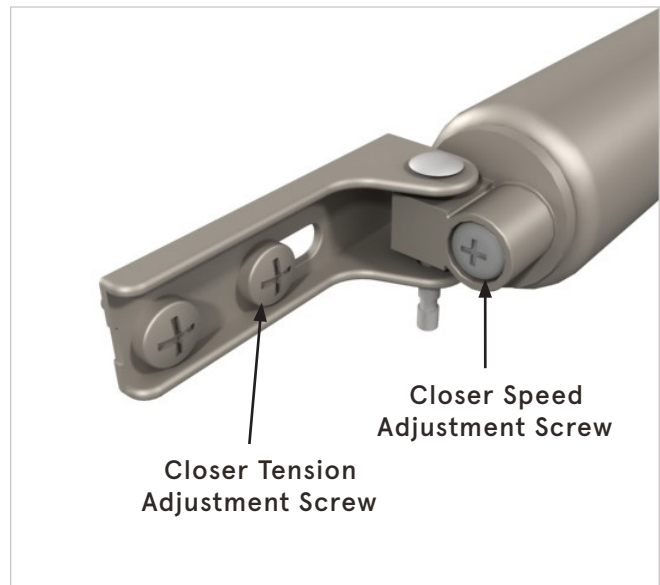

Bi-Fold Door

Operation and Maintenance

The bi-fold door slides to stack outward and requires very little maintenance to keep it functioning efficiently.

Most problems can be eliminated by keeping the sill clean — ensuring smooth door operation. Door handles, twin bolt handles, and magnetic door catches can be wiped down with a damp cloth to remove fingerprints and smudges. It is very seldom that door rollers, locks, and hinges require lubrication. Occasionally use spray lubricant to keep operation smooth (rollers are visible on the top in between each panel).

If the door needs adjustments, please contact your Infinity partner for either detailed instructions or for a service person to make adjustments for you. Visit infinitywindows.com/doors/bi-fold to find a video on proper operation.

Hardware Operation for Multi-Point Lock

Always close and lock your passive panel first and the operating panel (with thumb turn) second. Infinity's multi-point hardware has locking bolts at the head and base of the door. Lifting the handle 45 degrees upward will set the head and foot bolts in place for a secure seal. A 90 degree turn of the key from the outside or the thumb turn on the inside will lock the deadbolt in the handle assembly. When the deadbolt is unlocked, downward pressure on the handles will release the bolts and latch and the door will open. Securely lock by engaging the deadbolt, head, and foot bolts; using only one or the other does not offer full security. See Illustration on page 24.

The interior twin bolt handles effortlessly rotate up 180 degrees to unlock and open the door; rotate down to lock and secure. Magnetic door catches protect the panels and hardware when open.

Pleated Screen Operation and Cleaning

The bi-fold pleated fabric screen slides open from both sides and can be positioned as desired. Keep the guides clear of debris and wipe screen fabric down with a soft cloth and mild, soapy water. Lightly rinse and allow the screen mesh to dry before closing/retracting. You can register your bi-fold pleated screen with Infinity's Limited Lifetime Warranty within 60 days of product installation. See page 4 for more warranty details.

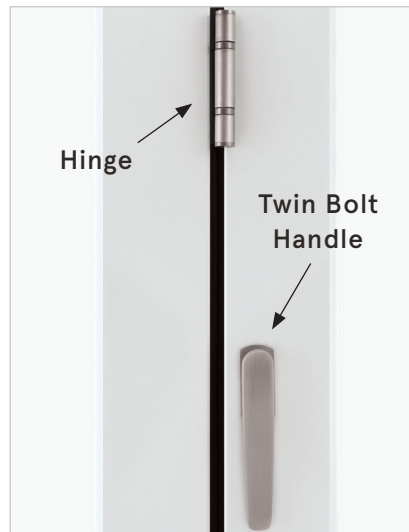
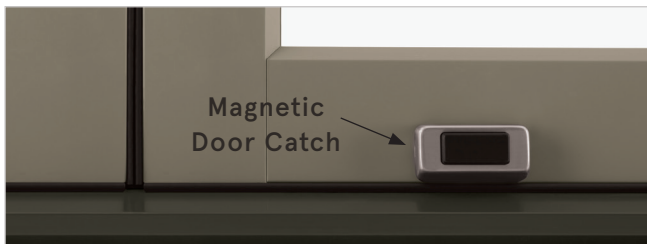

Still have questions? We can help.

Thank you for purchasing Infinity windows and doors for your home. We're always here to help, and our local partners are too. Give us a call or visit us online, anytime.

Call 1-800-372-1072 for homeowner support. In Canada, call 1-800-263-6161. Or visit us at infinitywindows.com.

©2024 Marvin Lumber and Cedar Co., LLC.
All rights reserved. ©Registered trademark of Marvin Lumber and Cedar Co., LLC.
ENERGY STAR® and the ENERGY STAR certification marks are registered U.S. marks.
Product specifications subject to change without notice.

Part #19970331. May 2024.

INFINITY[®]
from **MARVIN**
REPLACEMENT WINDOWS
Built for life[®]